

Revision Notes			
R1 -	Drawn -	Checked -	Approved -
AP.A -			Date -

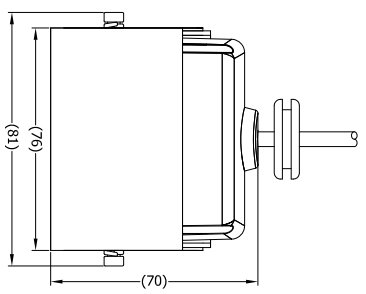

ITEM	PART NO.	QTY	MODEL / DESCRIPTION
①	(3180D)	1	VBV-700C-C CAMERA ONLY
②	(3189A)	1	VBV-711XXC-BRT CAMERA BRACKET
③	(3180A)	1	VBV-711XXC-SS CAMERA SUNSHIELD
④	(3191)	1	VBV-711XXC-FPK CAMERA SLING PACK
⑤	(3347B)	1	VBV-7X0C-IG INSTALLATION GUIDE (NOT SHOWN)

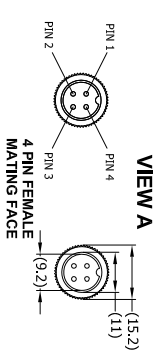
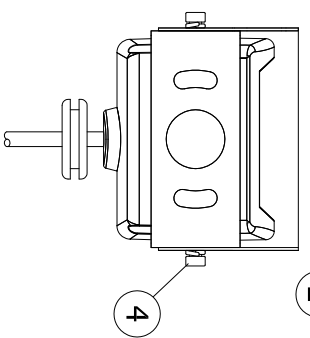
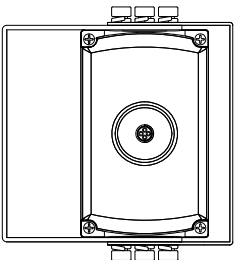
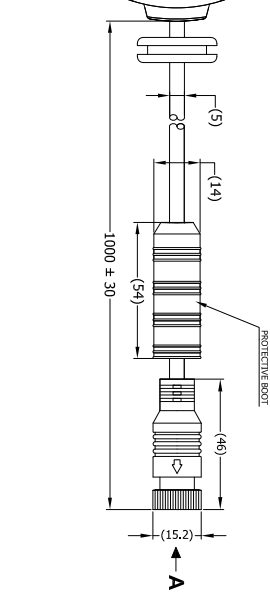
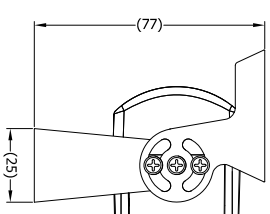
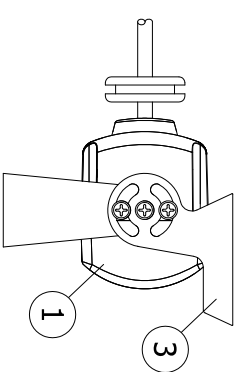
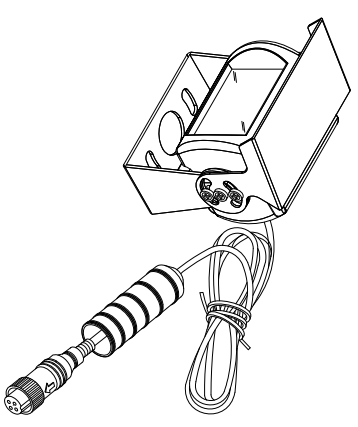

PIN #	WIRE COLOUR	DESCRIPTION
1	RED	+12V
2	BLACK/SHEILD	GND
3	WHITE	AUDIO
4	YELLOW	VIDEO

- NOTES:**
- REFER TO PRODUCT SPECIFICATION FOR PRODUCT SPECIFICATIONS.
  - REFER TO COMPONENT DRAWINGS FOR COMPONENT DETAILS
  - FOR GIFTBOX LABEL REFER TO LATEST REVISION OF DRAWING BE-003337-XX-16.
  - FOR GIFTBOX SERIAL NUMBER LABEL REFER TO REVISION OF DRAWING BE-001323-XX-10.
  - PURCHASE ORDER TO DEFINE PACKAGING VARIANT.
  - REFER TO LATEST REVISION OF DRAWING BE-001985-XX-12 FOR PACKAGING DETAIL.

**PROPRIETARY NOTICE**  
 THIS DESIGN AND TECHNICAL INFORMATION APPEARING ON THIS DRAWING IS THE PROPERTY OF BRIGADE ELECTRONICS, AND IS DISCLOSED IN CONFIDENCE. IT IS NOT TO BE COPIED, REPRODUCED, REVEALED TO OR EXPLOITED BY OTHERS, EITHER IN WHOLE OR IN PART WITHOUT THE EXPRESS WRITTEN CONSENT OF BRIGADE ELECTRONICS.

**BRIGADE**  
 www.brigade-electronics.com

<p>Angle of Projection Third Angle</p>	<p>Assembly Pl Approval YILING ZHANG (27/07/16)</p>	<p>Approved by B.JOHN</p>	<p>Checked by RBATES</p>	<p>Drawn by MBUTLER</p>
	<p>Status RELEASED</p>	<p>Units mm</p>	<p>Scale N/A</p>	<p>Released 27/07/16</p>
				<p>Part No 1379D</p>
				<p>BE-003339-00-16</p>

1 2 3 4 5 6 7 8

Frame V3